

INSTRUCTIONS

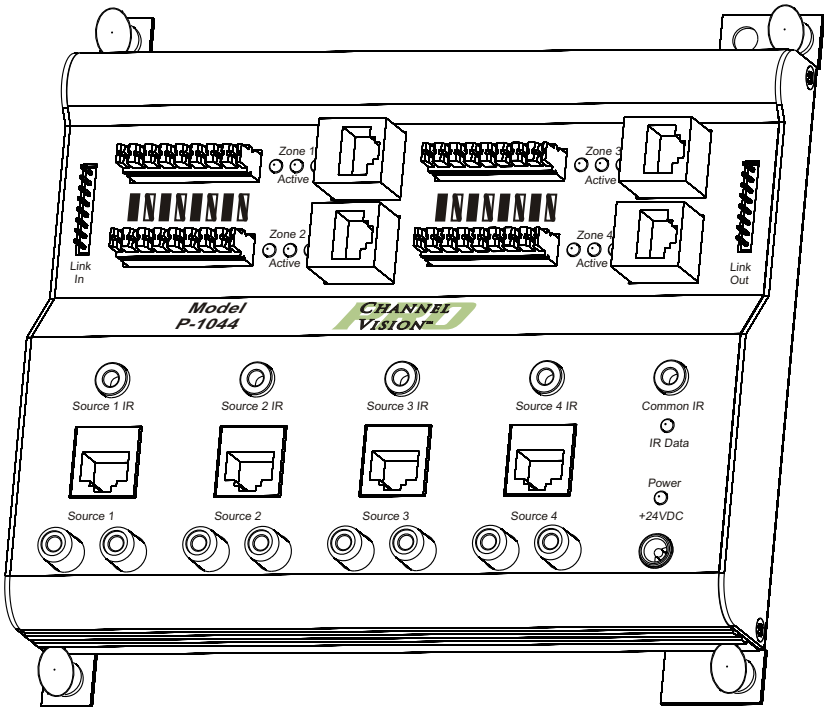

P-1044 **4-Source/4-Zone CAT5 Audio Matrix**

BY  CHANNEL VISION™

©2006 CHANNEL VISION TECHNOLOGY

The **P-1044** is a 4-source, 4-zone matrix switcher for Channel Vision's CAT5 audio system. It allows up to four different sources to be played in four different zones simultaneously, making it perfect for families with a variety of listening interests. Controlling your music is easy with the P-1044's source specific IR repeating which allows independent control of identical source components. For example, two identical CD players can be controlled independently.

Features:

- LED status indicators
- Source specific IR routing
- Input connections: RJ-45 or RCA
- Output connections: RJ-45 or 110 punchdown
- Compatible with Channel Vision's AB-124 amplified keypad

4 Zone Outputs

Allows connection of AB-124 keypads
 Provides for either 110 or RJ-45 (see note under LED Indicators)

LED Indicators

Blue LED indicates that the zone is active.
 Red LED indicates which connector is being used.
Note: Each zone will only support 1 keypad.
 If keypads are connected to both the RJ-45 and 110 connectors, only the keypad connected to the RJ-45 will be active and the red LED near the RJ-45 connector will be illuminated.

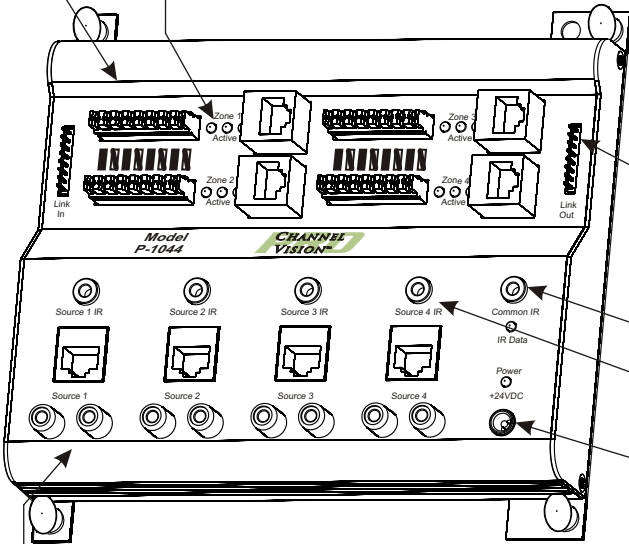

Link In/Link Out
 Allows for easy expansion by transferring IR signals to multiple units.

Common IR output
 IR output from all zones

Source specific IR outputs
 Only emits IR when a zone has this source selected

Power Connector
 Use AB-T2454 power supply

Audio Source inputs

Use RCA inputs to connect conventional audio sources.
 Use RJ-45 inputs to connect input modules such as AB-202, AB-301, and AB-311.

Compatibility

The P-1044 adheres to the same protocols as Channel Vision's other CAT5 audio hubs to ensure maximum compatibility. However, some amplified keypads (such as the AB-114) will not provide control of source selection. If the keypad provides IR pass through (as does the AB-114), you can use an A0501 remote control to make source selections. For best results we recommend using the AB-124 amplified keypad.

How it Works

The P-1044 is a matrix switcher for Channel Vision's CAT5 audio system. Any zone can independently select and listen to any source at any time. Source selection can be done either from an AB-124 amplified keypad or by using the A0501 remote control. For details on the A0501 remote control, please refer to the section of this manual titled "Using the A0501 Remote Control." The basic operation of the AB-124 is described below.

Using the AB-124 Amplified keypad...

The Pwr (power) button located at the lower left of the keypad is also used for source selection. When the AB-124 is powered on, press and release the power button to scroll through the input sources. As you change sources, you'll notice that the top 4 LEDs illuminate corresponding to the source you have selected. When source one is selected, the first LED is illuminated, when source two is selected, the second LED is illuminated, and so on.

After a source is selected the LED will stay lit for 5 seconds, then it will return to showing the current volume level.

Volume adjustments can be made using the up/down buttons to the right hand side of the keypad. The keypad can be controlled from the A0501 remote control (see the section titled: Using the A0501 remote control for more details).

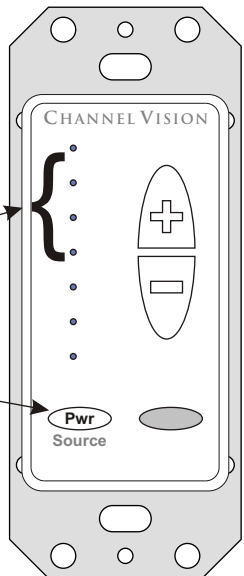

These four LEDs illuminate to indicate which source input is selected.

The Pwr button is used for source selection.

Basic Application

A basic system can be created with four amplified keypads (model AB-124) and four pairs of speakers. The source components can be controlled by pointing their remote control at the IR sensor in the AB-124 keypad.

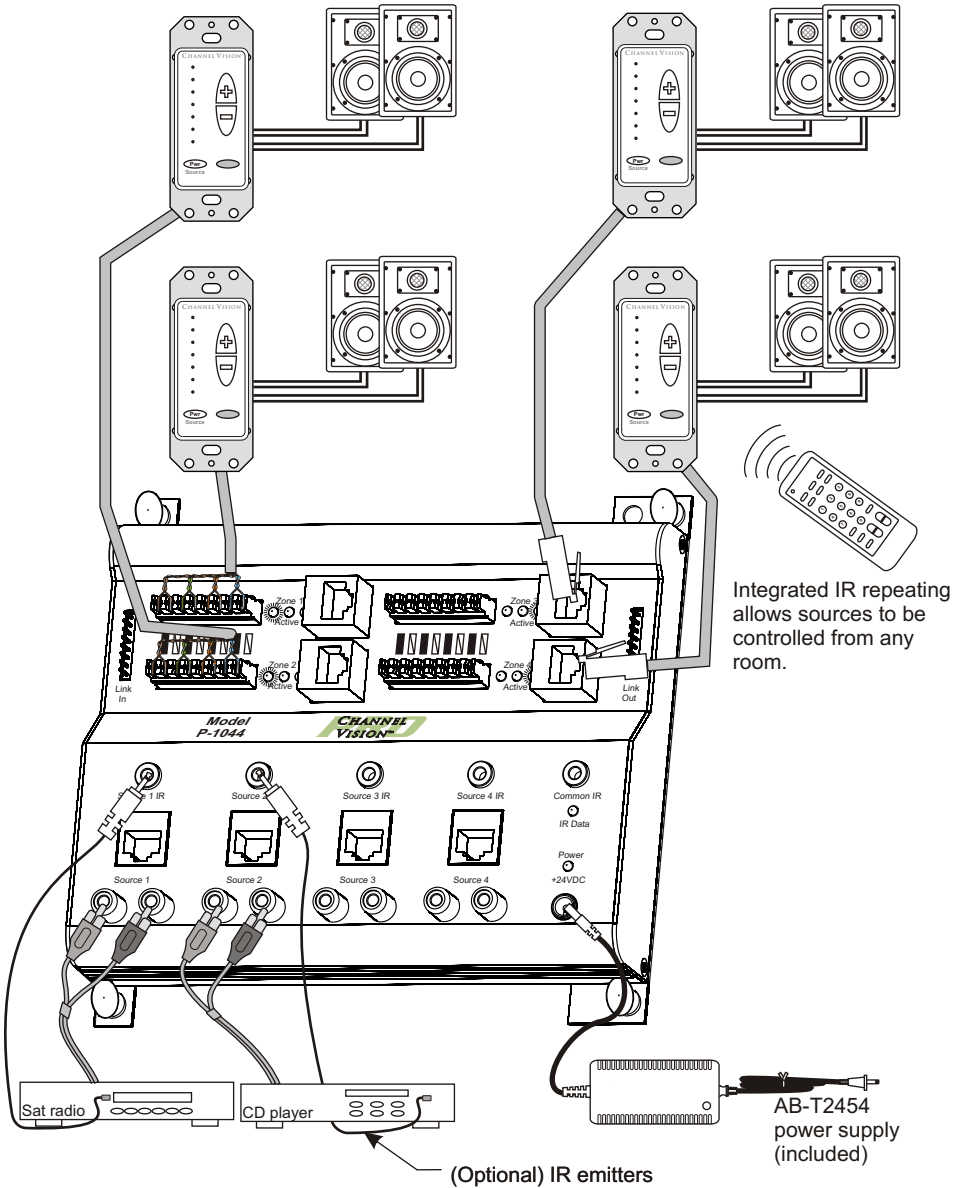

Expanding The System

Larger systems consisting of more than 4 zones can be created by adding a second P-1044. Use RCA 'Y' connectors to split the audio sources into both units. Use the provided ribbon cable to connect the "Link" terminals. This will allow IR signals received through one P-1044 to be transmitted to the other P-1044.

1 of 8 possible Amplified keypads

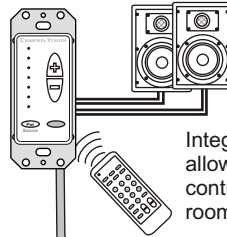

Integrated IR repeating allows sources to be controlled from any room.

Use the ribbon cable provided to connect "Link Out" from one unit to the "Link In" of the other unit. This will transfer IR signals between units.

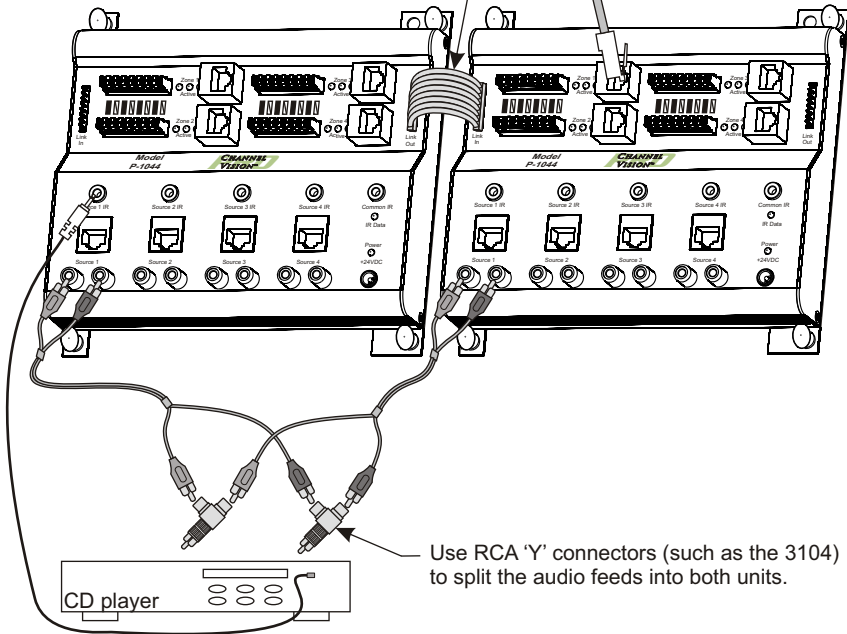

Use RCA 'Y' connectors (such as the 3104) to split the audio feeds into both units.

1 of 4 possible source devices.

Note: both units shown above must be powered by an AB-T2454 power supply. These power supplies are not shown in the diagram above.

Using Different Input Devices

The P-1044 can accept signals from either a standard analog audio output (via RCA inputs) or a CAT5 audio output from one of Channel Vision's CAT5 audio input modules.

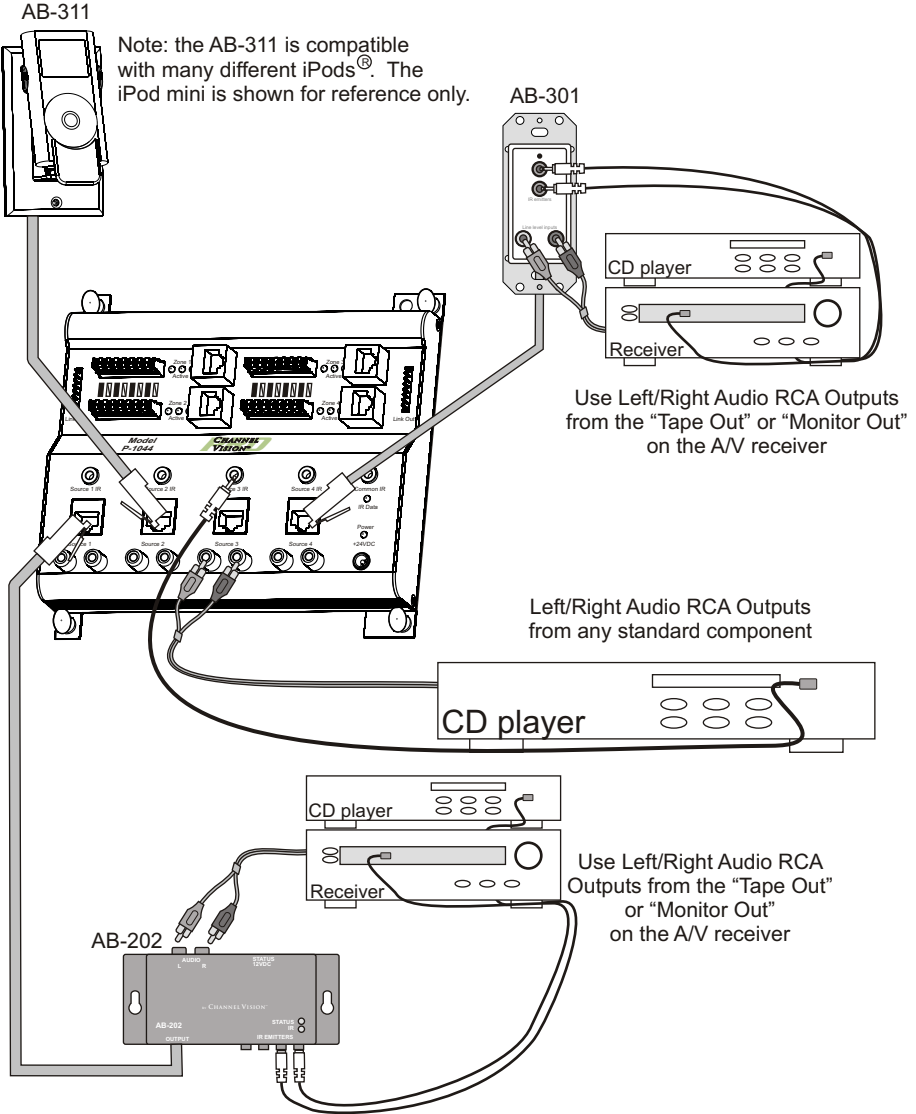

Integrating the P-1044 with other products

Many different components can be integrated together. The system below integrates a single-source CAT5 audio hub (model P-1014) as well as telephone paging modules. The keypads connected to the P-1014 will act as sub-zones to the P-1044. These sub-zones will all play the same audio which is perfect for common areas such as hallways, bathrooms, kitchen, or dining room. Adding the C-0920 and P-0925 allows paging to occur in these common areas.

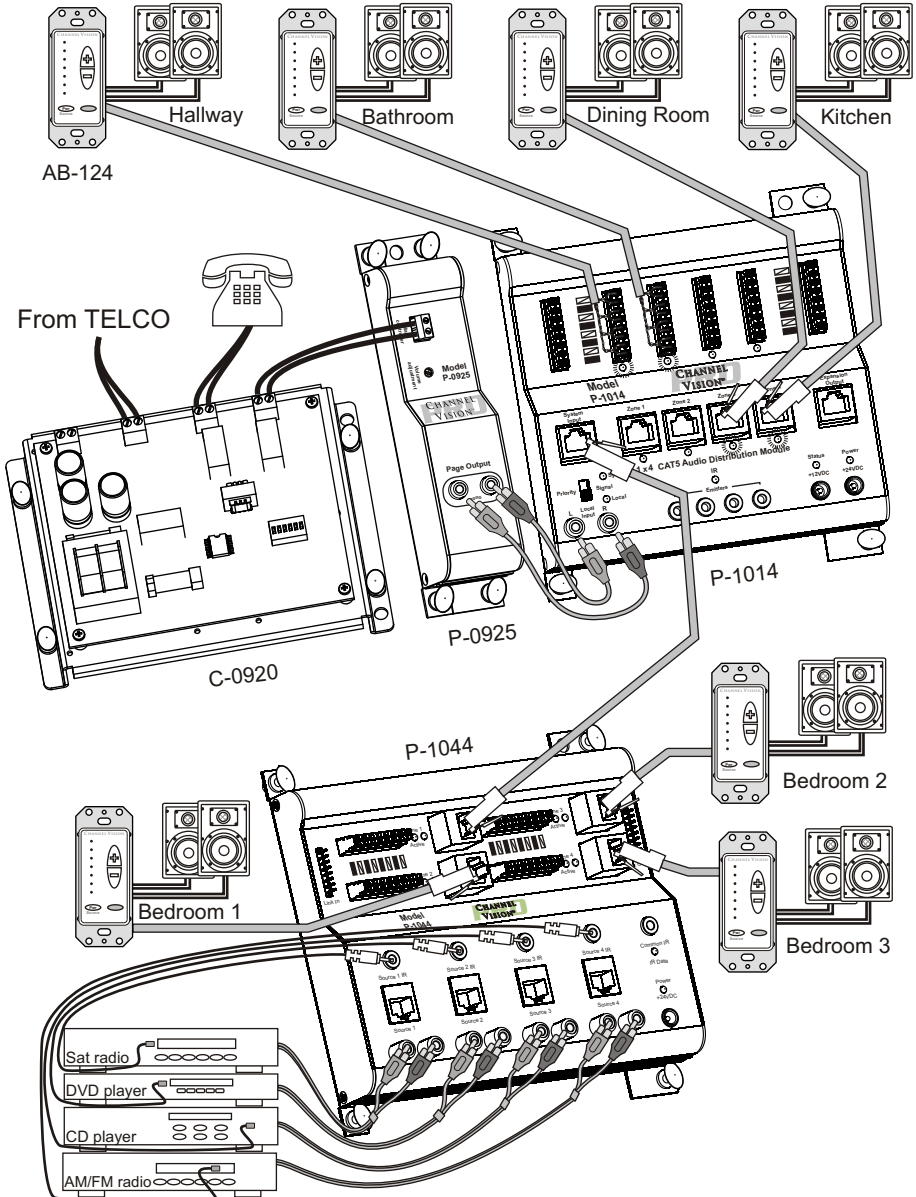

Using the A0501 remote control

The A0501 is designed to allow you to control your P-1044 without having to touch the buttons on the AB-124. Simply point the A0501 remote control at the IR sensor located at the bottom of the AB-124 and press the desired button.

Zone Power - Turns off the output of the P-1044.

Power - Turns off the AB-124.

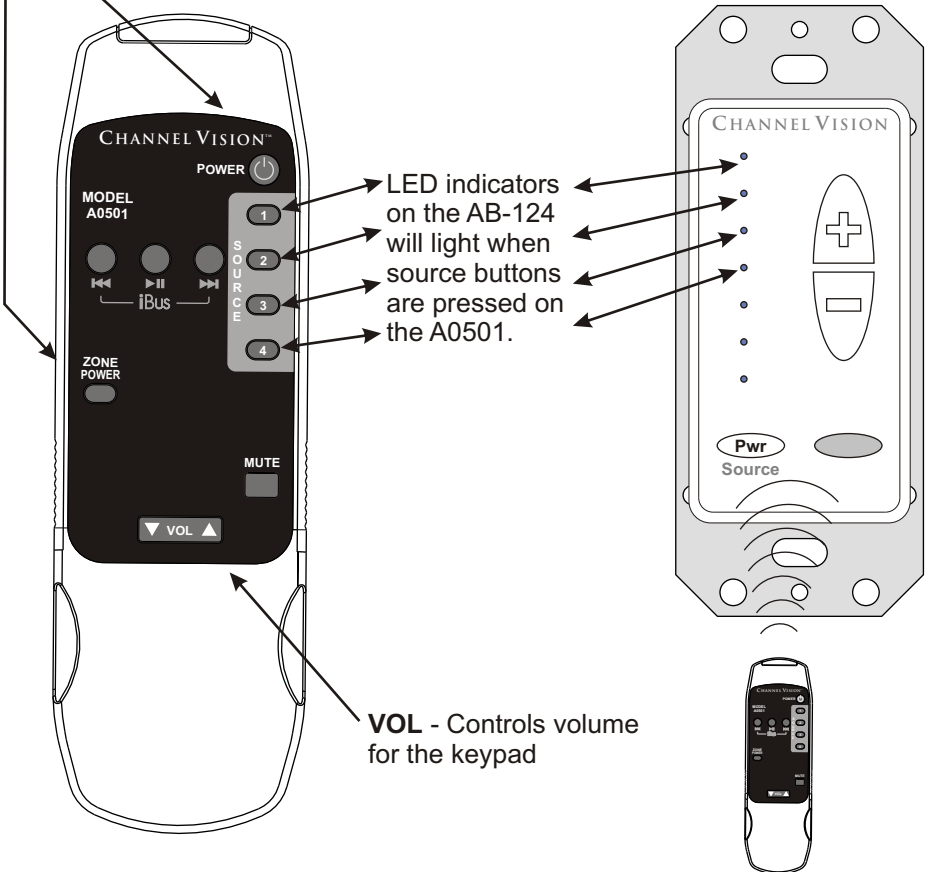

Downloading IR commands...

If you don't have access to the A0501 remote and you need to program a learning remote, you can download the IR codes from the internet. IR codes compatible with the Philips Pronto remote controls can be downloaded from the following websites:

www.channelvision.com (codes in Hex format)

www.remotecentral.com (codes in Pronto format)

Mounting Options

The **P-1300** from Channel Vision's Pro-series product line is the perfect home for the P-1044. The P-1300 is a hinged plate designed to fit into a standard 19" rack.

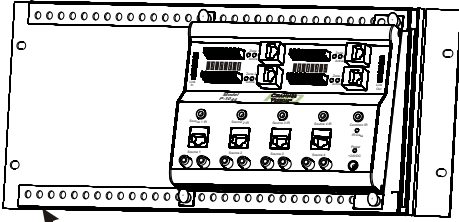
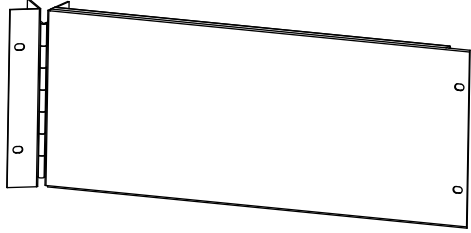

The **P-1300** hinges open to maintain a clean look and provide easy access for servicing equipment.

The P-1044 can also be mounted in a standard structured wiring enclosure or screwed to a wall or flat surface as shown below.

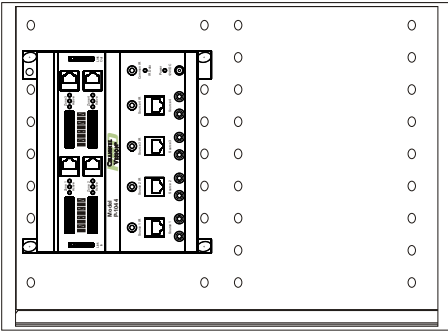

For wall mounting:
Cut or remove the
nylon snap pins.

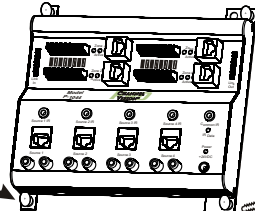

Install screws in empty holes.

Connection Tips and Troubleshooting

- 1) Be sure you have connected the CAT5 cable correctly. Note that the stripe/solid pattern should match the labels on the product. Miss-wiring can cause distorted sound or prevent the system from working at all!
- 2) Be sure you have connected the speakers in phase. Follow the label on the product. Out of phase speakers can rob the system of its bass, especially when driving dual-voice-coil speakers.
- 3) Be sure IR emitters are directly over the IR sensor for all devices you wish to control.
- 4) If no audio is heard in a zone... inspect the status LEDs for that zone. The red LED next to the output you are using should be illuminated and so should the blue LED labeled "Active". Note that there are two red LEDs for each zone output, one for RJ-45 connector and one for the 110 connector. These red LEDs indicate which output connector is being used (only one can be used at a time). If you connect keypads to both of these connectors simultaneously, only the RJ-45 output will be activated.
- 5) If no audio is heard and the blue LED labeled "Active" is not lit... Make sure that audio is playing (it must be playing for the Active light to come on). If music is playing, re-issue the source command (i.e. re-select the source using the remote or keypad).
- 6) If a CAT5 wire is connected to the P-1044, make sure the other end is terminated with a keypad. If the CAT5 wire is left un-terminated while the other end is attached to the P-1044, it may be possible for the conductors in the rough end of the CAT5 to short together and cause problems for the system.
- 7) If one of the source inputs is not working try connecting that source into one of the working source inputs. If the problem persists check the cabling between the source and the P-1044.

Stripping and Connecting CAT5 Wire

CAT5 cable should be stripped with a proper stripping tool, such as Channel Vision's J-110 tool.

1. Place the CAT5 between the blade and the first notch of the J-110 tool.

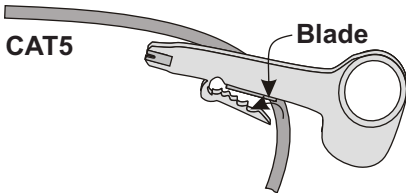

2. Rotate the tool only once. Multiple turns will cause you to cut into the inner wires.

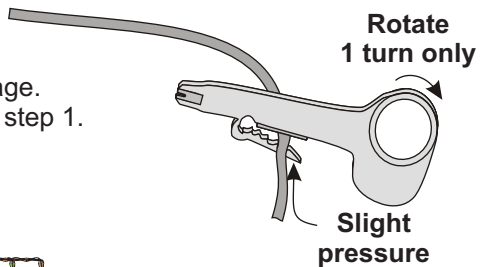

3. Inspect the inner wires for damage. If any wires are cut start over at step 1.

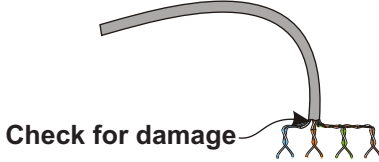

TIA-568A RJ-45 Modular Plug

Side view:

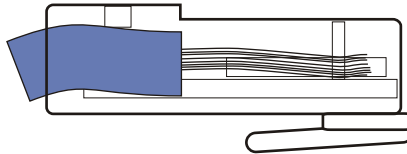

Top view:

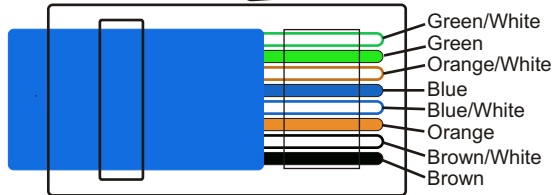

Specifications: (typical @25° C)

Operating Voltage : 24±.5VDC

Cable requirements: CAT5 or better

Speaker impedance: 6-8 ohm

IR repeating: 30-60kHz

IR sensor range (AB-124): 40'@40kHz, 25'@56kHz

Operating Temperature: -10°C to +50°C

Specifications subject to change without notice.

iPod is a trademark of Apple Computer, Inc., registered in the U.S. and other countries.



CHANNEL VISION™
2 Year Limited Warranty

Channel Vision Technology will repair or replace any defect in material or workmanship which occurs during normal use of this product with new or rebuilt parts, free of charge in the USA, for two years from the date of original purchase. This is a no hassle warranty with no mail in warranty card needed. This warranty does not cover damages in shipment, failures caused by other products not supplied by Channel Vision Technology, or failures due to accident, misuse, abuse, or alteration of the equipment. This warranty is extended only to the original purchaser, and a purchase receipt, invoice, or other proof of original purchase date will be required before warranty repairs are provided.

Mail in service can be obtained during the warranty period by calling (800) 840-0288 toll free. A Return Authorization number must be obtained in advance and can be marked on the outside of the shipping carton.

This warranty gives you specific legal rights and you may have other rights (which vary from state to state). If a problem with this product develops during or after the warranty period, please contact Channel Vision Technology, your dealer or any factory-authorized service center.



CHANNEL VISION™
channelvision.com

234 Fischer Avenue, Costa Mesa, California 92626
(714)424-6500 • (800)840-0288 • (714)424-6510 fax

500-129 revB